

12G-SDI

Studio / Broadcast Monitor

13.3"/15.6"/17.3"/23.6"/28"/31.5" 3840×2160 Resolution,
features with quad split multiview

User Guide



Contents

Important Safety Instructions:2

Precaution: 2

1. Main Features3

2. Production Description 4

 2.1 Front Panel 4

 2.2 Rear Panel 5

3. Menu Setting 8

 3.1 Shortcut keys 8

 3.2 MENU Operations9

4. Product Parameters 26

5. Accessories 26

6. Trouble Shooting 27

Appendix 1: 3D LUT Loading 28

Appendix 2: Remote Terminal Instructions 30

Important Safety Instructions:

- Please read User Guide before using this product.
- Please keep User Guide for future reference.
- Please read the precaution to prevent possible danger and loss of property.

Precaution:

- Please do not place the display screen towards the ground.
- Please avoid heavy impact or drop onto the ground.
- Please do not use chemical solutions to clean this product. Please wipe with a clean soft cloth to maintain the brightness of the surface.
- Please do not block any vent hole.
- Please follow the instructions and trouble-shootings to adjust the product. Other improper adjustment may result in damage. Any further adjustment must be performed or conducted by a qualified technician.
- Please unplug the power and remove the battery if long-term no-use, or thunder weather.

1. Main Features

- Support standard 12G-SDI input interface (x2), 3G-SDI input interface (x2), and support Single-Link, Dual-Link and Quad-Link signals.
- Support HDMI 2.0/ 1.4 inputs and loop outputs.
- Support SFP input, optical module for optional.
- Support Quad Split Multiview
- Input signals support up to 3840x2160 60/ 59.94/ 50/ 30/ 29.97/ 25/ 24/ 23.98p and 4096x2160 60/ 59.94/ 50/ 48/ 47.95/ 30/ 29.97/ 25/ 24/ 23.98p; Signal loop out.
- 12 bits data processing and 12 bits data buffering
- Monitor control via GPI/ RS422/ LAN.
- Customized Menu Knob.
- Support customized various waveform mode: Waveform/ Vector/ Histogram/ Audio Vector/ Level Meter.
- HDR (High Dynamic Range) display supporting ST 2084/ Hybrid Log Gamma.
- Gamma selection: 1.8-2.8.
- Custom 3D LUT file load through USB.
- Gamut supporting SMPTE-C/ Rec709/ EBU.
- Color Space/ HDR/Gamma / Camera Log comparison with original (side by side).
- Color Temperature: 3200K/ 5500K/ 6500K/ 7500K/ 9300K/ User.
- False Color: Default/ Spectrum/ ARRI/ RED.
- Aspect Marker (16:9/ 1.85:1/ 2.35:1/ 4:3/ 3:2/ 2.0X/ 2.0X MAG/ Grid/ User).
- Aspect (Full/ 16:9/ 1.85:1/ 2.35:1/ 4:3/ 3:2/ 2.0X/ 2.0X MAG).
- Audio: supporting Audio Vector, Level Meter, (HDMI supporting 8 channels/ SDI supporting 16 channels).
- Time Code: LTC/ VITC.
- UMD display: White/ Red/ Green/ Blue/ Yellow/ Cyan/ Magenta text color for optional.
- Color Bar Mode: Rec601/ Rec709/ BT2020.
- Check Field: Red/ Green/ Blue/ Mono.
- Zoom at any position and at different scale.
- Peaking (Red/ Green/ Blue/ White/ Black).
- Tally (Red/ Green/ Yellow).

2. Production Description

2.1 Front Panel

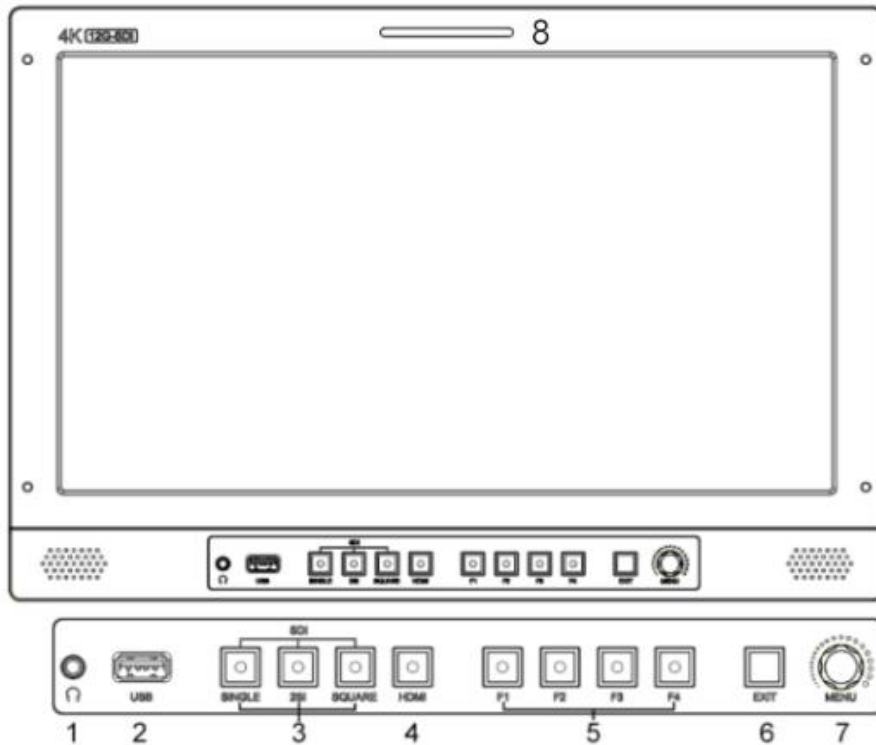

1) Earphone Jack

2) USB (For 3D LUT load and software update)

3) SDI Buttons

- Single Button/ Lamp: SDI1/ SDI2/ SDI3/ SDI4/ SFP signal input.

-MV1 Input Button (Quad Mode): SDI1/SDI2/SDI3/SDI4/SFP/HDMI signal input.

- 2SI Button/ Lamp

-MV2 Input Button (Quad Mode):SDI1/SDI2/SDI3/SDI4/SFP/HDMI signal input.

- Square Button/ Lamp

-MV3 Input Button (Quad Mode):SDI1/SDI2/SDI3/SDI4/SFP/HDMI signal input

4) HDMI Button/ Lamp

-MV4 Input Button (Quad Mode):SDI1/SDI2/SDI3/SDI4/SFP/HDMI signal input

5) F1/ F2/ F3/ F4 Button and Lamp

Assigned function by factory as follow:

- [F1]: Peaking

- [F3]: Waveform

- [F2]: Level Meter

- [F4]: Color Space

6) Exit Button

Under Quad Mode: Display the signal input status

7) Menu Knob

8) TALLY (indicator light)

2.2 Rear Panel

2.2.1 Interfaces

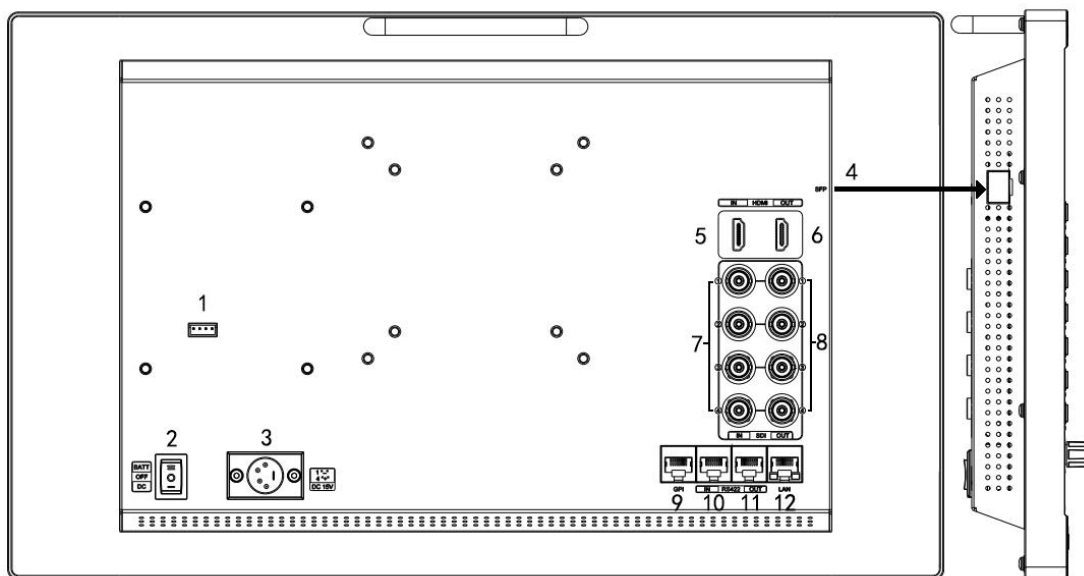

1) 4pin power input for V-mount/ Anton Bauer mount battery plate.

2) Power Switch: “O” is power off, “II” is battery power supply, “I” is DC power supply.

3) Power IN: 4-pin XLR DC.

4) SFP Input

5) HDMI 2.0 Input

6) HDMI 2.0 Output

7) SDI Input

- 12G-SDI Input *2

- 3G-SDI Input *2

8) SDI Output

- 12G-SDI Output *2

- 3G-SDI Output *2

9) GPI Input (RJ45, 8-pin): See Page 22 GPI 1-8.

10) RS422 Input (RJ45, 8-pin): Supporting the default and TSL V3.1 protocols to control Monitor.

Follow this instructions about this port.

PIN Number	Instruction
PIN 1	Y
PIN 2	Z
PIN 3	A
PIN 4	NC
PIN 5	NC
PIN 6	B
PIN 7	NC
PIN 8	GND

11) RS422 Output (RJ45, 8-pin): Supporting the default and TSL V3.1 protocols to control Monitor. The instructions about the port is as above.

12) LAN (10/ 100) Input (RJ45): Supporting the default protocol to control Monitor.

Note: The "RemoteTerminal.exe" as default protocol to control Monitor.

2.2.2 Standard VESA

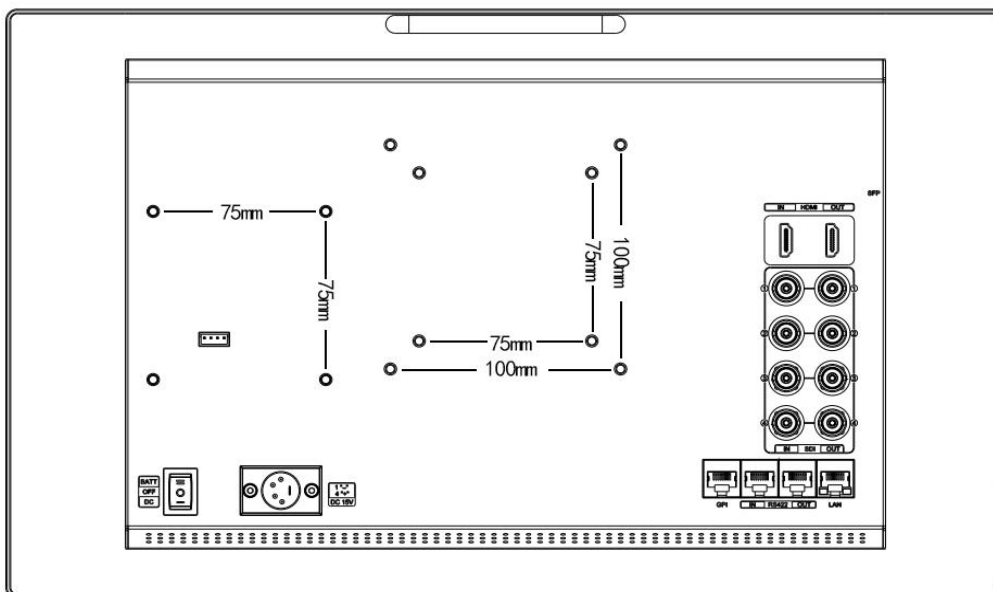

- Standard 75mm*75mm is used for external battery (V-mount/ Anton Bauer mount battery).

- Standard 75mm*75mm and 100mm*100mm, can be used for external hanging bracket.

Process of Installing Battery Plate:

- Install the plate base before installing the battery plate.

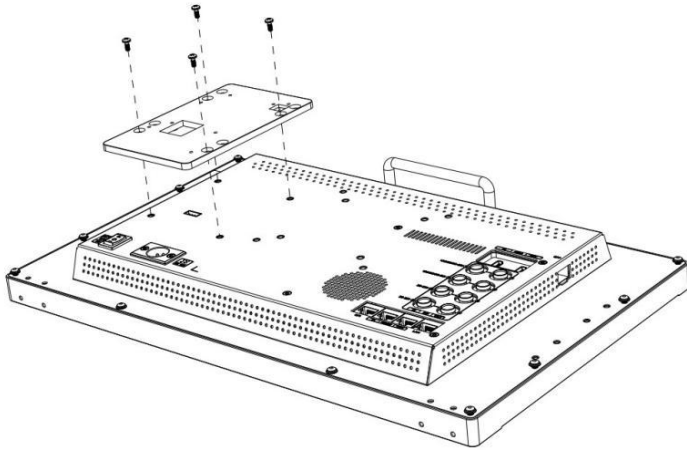

- Standard with V-mount battery plate: Referring to the following pictures for installation process and GP-L130AB type battery.

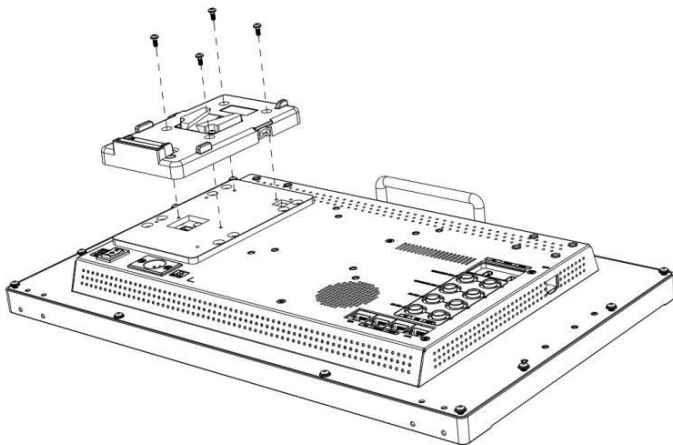

GP-L130AB

- Optional Anton Bauer battery plate. Referring to the following pictures for installation process and GP-L130B type battery.

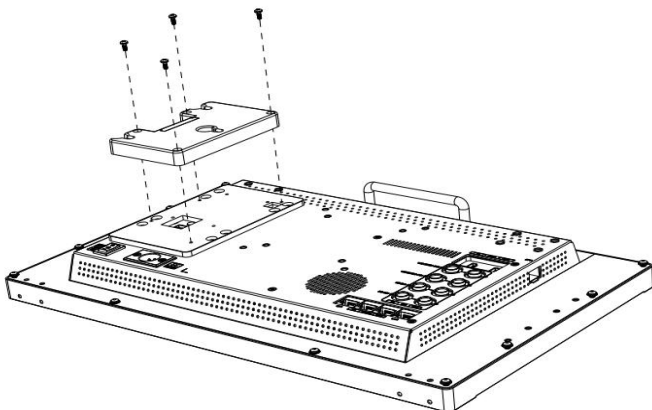

GP-L130B

3.2 MENU Operations

3.2.1 PICTURE

SDI Mode			HDMI Mode		
PICTURE			PICTURE		
	Brightness	50		Brightness	50
	Contrast	50		Contrast	50
	Saturation	50		Saturation	50
	Tint	50		Tint	50
	Sharpness	0		Sharpness	0
	Color Space	Rec709		RGB Range	Limited
	Camera Log	Off		HDMI EDID	4K
	Def. Log	SLog2T oLC-709		Color Space	Rec709
	SDI2	▼▲		HDMI	▼▲

- **Brightness**
Control the degree of brightness between 0-100.
- **Contrast**
Control contrast ratio between 0-100.
- **Saturation**
Adjust the color intensity between 0-100.
- **Tint**
Adjust tint between 0-100.
- **Sharpness**
Control sharpness of the image between 0-100.
- **RGB Range**
Use this item to choose the RGB range of the HDMI input: [Full], [Limited].
- **HDMI EDID**
Select the HDMI EDID from between [4K] and [2K]. This item enables PC or other devices to recognize the property of this monitor and makes the images look excellent on the screen.
- **Color Space**
Select the display gamut from among [Native], [SMPTE-C], [Rec709], [EBU], [BT2020].
Note: for the 17.3inch and 31.5 inch monitor, the gamut can be selected among of [DCI-P3], [Native],

[SMPTE-C], [Rec709], [EBU] and [BT2020].

● **Camera Log**

Use this item to choose one of the camera Log modes:

- [Off]: Turn off Camera Log.

- [Def. Log]: Use this item to choose one of the Camera Log modes as the following sequence:

[SLog2ToLC-709], [SLog2ToLC-709TA], [SLog2ToSLog2-709], [SLog2ToCine+709], [SLog3ToLC-709], [SLog3ToLC-709TA], [SLog3ToSLog2-709], [SLog3ToCine+709],[ArriLogCTo709], [ArriLogCToP3DCI], [CLogToV709], [VLogToV709], [JLog To709], [JLogTo709HLG], [JLogTo709PQ], [Z7 NLogTo709], [D780 NLog To709].



- [User Log]: Use this item to choose one of the User Log modes (1-6). Please install the User Log as following steps:

The User Log must be named with .cube in the suffix. Please note: the device only supports the format of User Log: 17x17x17 / 33x33x33; Data order is BGR; Table order is BGR. If the format does not meet the requirement, please use tool “Lut Tool.exe” to transform it. Naming the User Log as User1-User6.cube, then copy the user Log into USB flash disk. Insert the USB flash disk to the device, the User Log is saved to the device automatically at the first time. If the User Log is not loaded for the first time, the device will pop up a prompt message, please choose whether to update or not.

● **Gamma**

Use this item to choose the display Gamma: [Off], [1.8], [2.0], [2.2], [2.35], [2.4], [2.6], [2.8].



Gamma 1.8

Gamma 2.8

Note: Gamma mode can be only activated while HDR function closed.

- **HDR**

Use this item to choose one of the HDR presets: [Off], [ST 2084 300], [ST 2084 1000], [ST 2084 10000], [HLG].

- **Back Light Mode**

Adjust the level of the back light from 0 to 100.

- **Color Temp.**

Use this item to choose one of the color temperature presets: [3200K], [5500K], [6500K], [7500K], [9300K], [User].

Note: Only available under [User] mode to adjust R/G/B Gain and Offset.

- **R/G/B Gain**

Adjust the R/G/B Gain of the current Color Temperature from 0 to 255. Default value: 128.

- **R/G/B Offset**

Adjust the R/G/B Offset of the current Color Temperature from 0 to 511. Default value: 256.

3.2.2 MARKER



- **Center Marker**

Select [On] to display the center marker “+” and [Off] not to display it.

- **Center Marker Size**

When [Center Marker] is activated, its size can be selected. [Small], [Middle] and [Large] are for optional. Default option: [Middle].

- **Aspect Marker**

Select the aspect ratio of the marker: [Off], [16:9], [1.85:1], [2.35:1], [4:3], [3:2], [2.0X], [2.0X MAG], [Grid], [User].

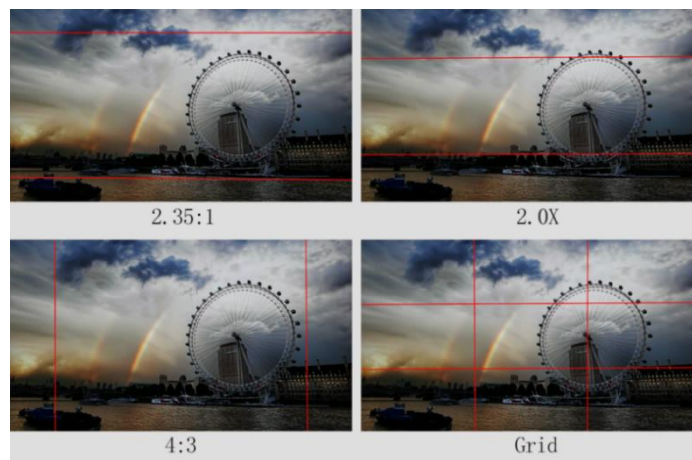

- **Safety Marker**

- Select [Off] not to display the safety marker. When this item is used with the aspect marker, it is only in aspect marker. When [Aspect Marker] is selected as [User], the safety marker does not be changed.

- Select the size of the safety markers: [95%], [93%], [90%], [88%], [85%], [80%].

Note: When [Aspect Marker] is selected as [Grid], the safety marker cannot be displayed.

- **Marker Color**

Select the color of marker displayed on the screen: [Red], [Green], [Blue], [White], [Black].

- **Aspect Mat.**

When activated, it can be selected from 1-7 (Step value is 1).



- **Thickness**

Adjust the thickness of all the marker lines from 1-15 (Step value is 1).

- **User Marker**









H1/H2: Adjust the position of vertical markers from 1 to 3840 (Step value is 1).

V1/V2: Adjust the position of horizontal markers from 1 to 2160 (Step value is 1).

Note: User maker only in [Aspect Maker]- [User] mode available.

Note: The Marker function is not available in Quad Mode.

3.2.3 FUNCTION

FUNCTION		
	Scan	Aspect
	Aspect	Full
	Overscan	Off
	H/V Delay	Off
	Check Field	Off
	Zoom	50%
	Freeze	Off
	SDI2	

MV Mode: Off、Quad

MV1 Source: SDI1/SDI2/SDI3/SDI4/SFP/HDMI signal input

MV2 Source: SDI1/SDI2/SDI3/SDI4/SFP/HDMI signal input

MV3 Source: SDI1/SDI2/SDI3/SDI4/SFP/HDMI signal input

MV4 Source: SDI1/SDI2/SDI3/SDI4/SFP/HDMI signal input

Frame Line Color: Off, 2, 4, 6, 8, 10, 12, 14

MV1 Frame Line Color: White, Red, Green, Blue, Yellow, Cyan, Magenta

MV2 Frame Line Color: White, Red, Green, Blue, Yellow, Cyan, Magenta

MV3 Frame Line Color: White, Red, Green, Blue, Yellow, Cyan, Magenta

MV4 Frame Line Color: White, Red, Green, Blue, Yellow, Cyan, Magenta

- **Scan**

Adjust the scan mode among [Aspect], [Pixel To Pixel], [Zoom].

Note: Aspect and overscan functions only can be adjusted only under [Aspect] mode. Both of them cannot

be adjusted in [Zoom] and [Pixel To Pixel] modes.

Note: The Scan function is not available in Quad Mode.

- **Aspect**

Select the aspect of the image among [Full], [16:9], [1.85:1], [2.35:1], [4:3], [3:2], [2.0X], [2.0X MAG].

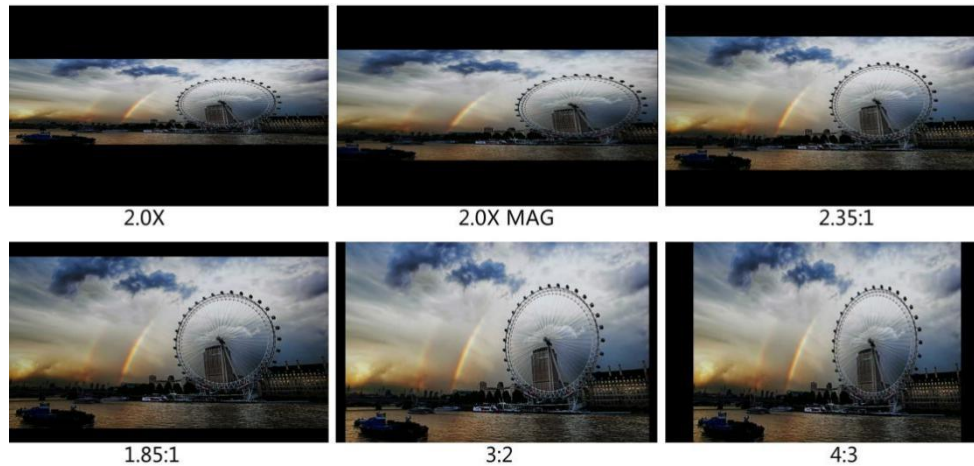

Note: The Aspect function is not available in Quad Mode.

- **Overscan**

Use this item to activate or deactivate overscan.

Note: The Overscan function is not available in Quad Mode.

- **H/V Delay**

Select one of the H/V modes: [OFF], [H], [V], [H/V]. When H/V Delay on, the blanking portions of the input signal will be displayed horizontally and vertically.

Note: The H/V Delay function is not available in Quad Mode.

- **Check Field**

Select one of check field modes: [Off], [Red], [Green], [Blue], [Mono].

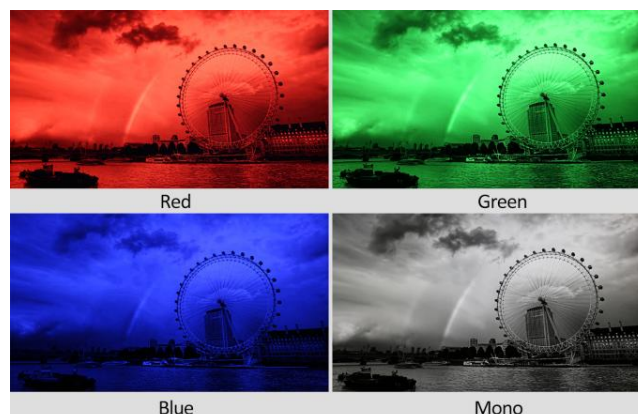

- **Zoom**

Select zoom scale from 10% to 90% (Step value is 10%).

When you select [Scan] as [Zoom], any part of the enlarged image can be displayed on the screen via the Menu Knob.

Note: The Zoom function is not available in Quad Mode.

● **Freeze**

Choose [On] to capture one frame of current image on the screen, and choose [Off] to close freeze function.

Note: The Freeze function is not available in Quad Mode.

3.2.4 WAVEFORM

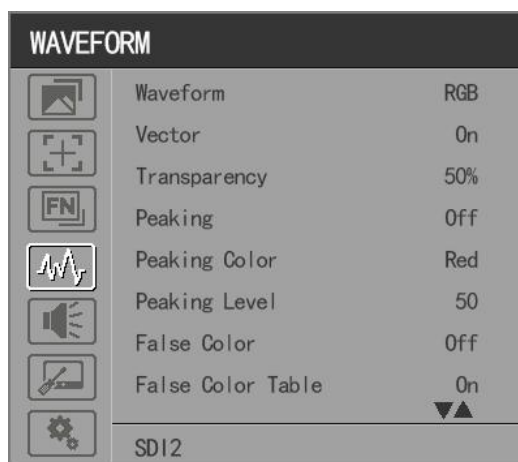

● **Waveform**

Use this item to activate or deactivate Waveform. Select the waveform mode from among [Multi], [Y], [YCbCr], [RGB].

- [Multi]: Display waveform, histogram, audio vector, vector, and level meter simultaneously.
- [Y]: Display Y Waveform.
- [YCbCr]: Display YCbCr Waveform.
- [RGB]: Display R/G/B Waveform.

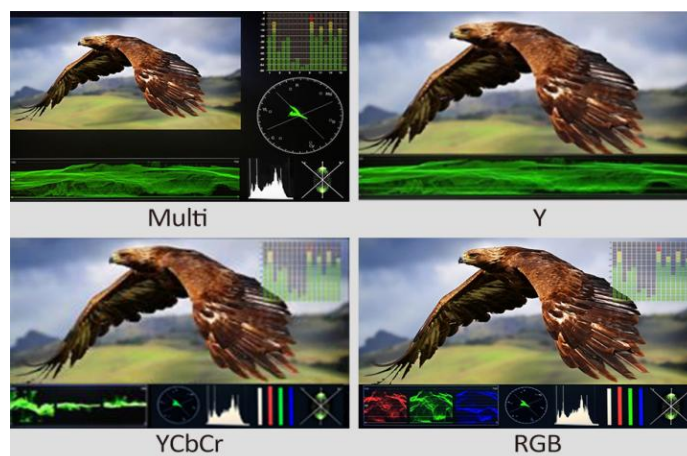

Note: The Waveform function is not available in Quad Mode.

- **Vector**

Use this item to activate or deactivate Vector.

Note: The Vector function is not available in Quad Mode.

- **Transparency**

Adjustment of transparency can support waveform, vector, histogram, audio vector, level meter.

Transparency can be selected from among [off], [25%], and [50%].

- [Off]: The background of waveform is shown at black.
- [25%]: The background of waveform is shown at 25% intensity.
- [50%]: The background of waveform is shown at 50% intensity.

- **Peaking**

Use this item to activate or deactivate the peaking function.

- **Peaking Color**

Select one of the peaking colors: [Red], [Green], [Blue], [White], [Black].

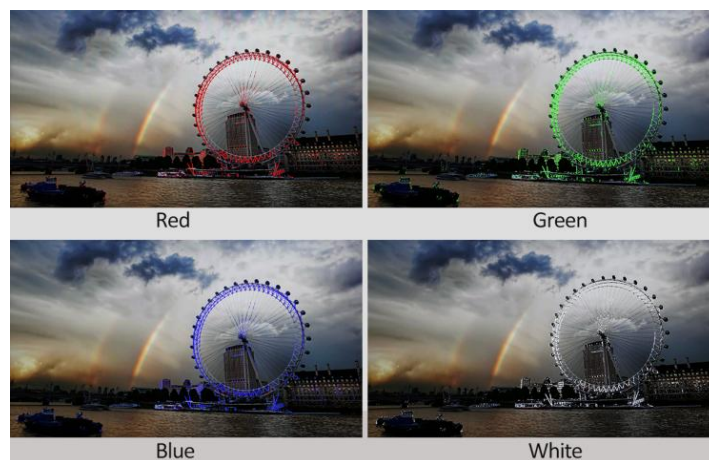

- **Peaking Level**

Use this item to adjust the level of peaking from 1-100. The higher peaking level is, the more obvious peaking effect is.

- **False Color**

Use this item to activate or deactivate the false color function.

When activated, [Default], [Spectrum], [ARRI], [RED] are for optional.

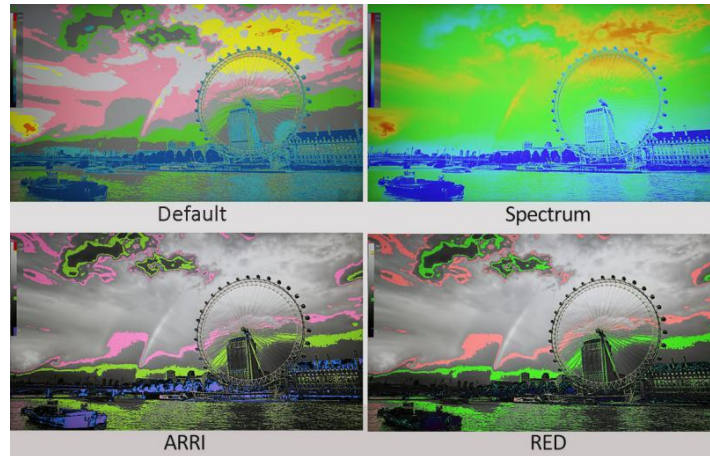

- **False Color Table**

Use this item to activate or deactivate the false color table. The range of the false color table is between 0-100 IRE.

- **Exposure**

Use this item to activate or deactivate the exposure function.

When activated, exposure works if the input signal exceeds the designated exposure level.

- **Exposure Level**

Use this item to adjust the level of exposure between 50-100 IRE.

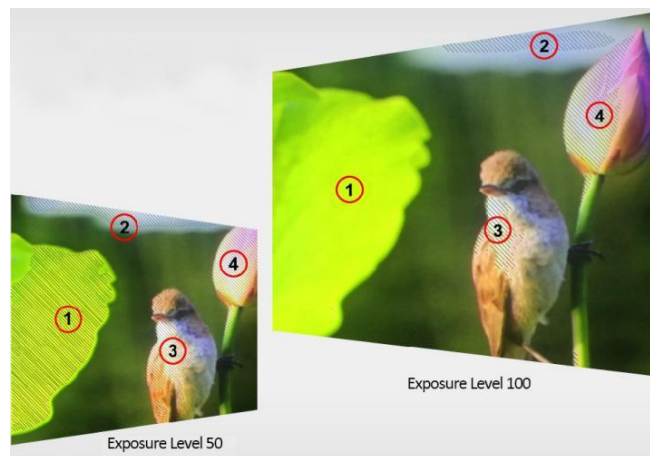

- **Histogram**

Use this item to activate or deactivate histogram. When activated, [Y], [RGB], [Color] are for optional.

- [Y]: Display Y histogram.
- [RGB]: Display RGB mixed histogram.
- [Color], Display RGB separated histogram.

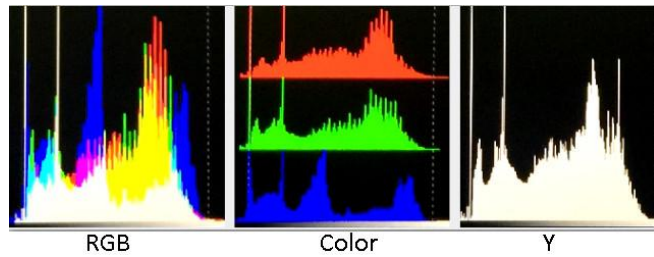

Note: The Histogram function is not available in Quad Mode.

- **Time Code**

Use this item to activate or deactivate the Time Code. When activated, [LTC], [VITC] are for optional.

Note: Time code is only available under SDI mode.

3.2.5 AUDIO

AUDIO		
	Volume	50
	Level Meter	On
	Audio Vector	On
	Vector Ch	CH1&CH2
	Audio Left Out	CH1
	Audio Right Out	CH2
	SDI2	

- **Volume**

Adjust the volume among 0-100.

- **Audio Source:SDI1/SDI2/SDI3/SDI4/SFP/HDMI**

Note: The Audio Source is only available under Quad mode.

- **Level Meter**

Select whether to activate or deactivate level meter.

Note: Default as on under [Waveform]-[Multi] function.

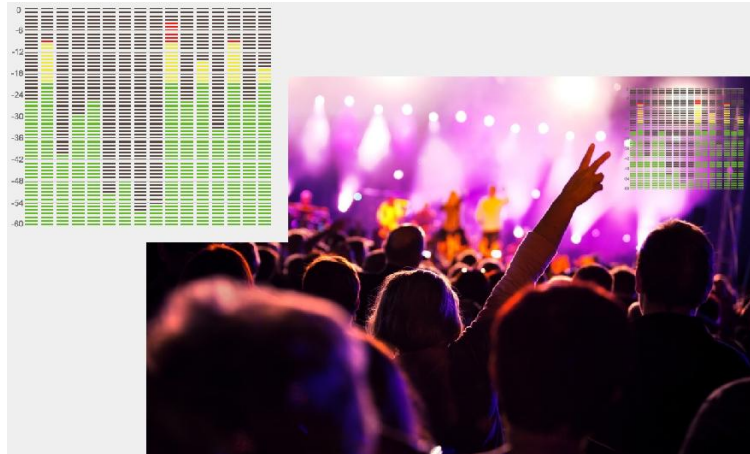

- **Audio Vector**

Select whether to activate or deactivate audio vector. Audio phase can be monitored by the audio vector.

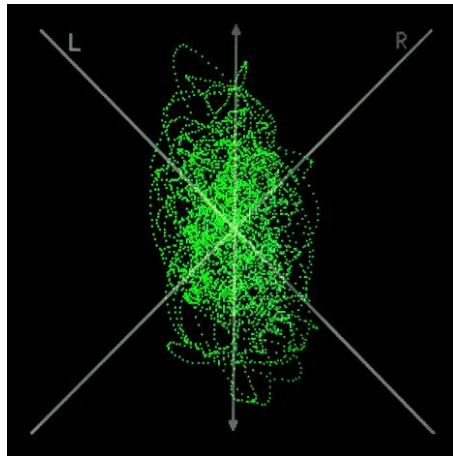

Note: The Audio Vector is not available under Quad mode.

- **Vector Ch.**

In HDMI mode, select the vector channels from among [Ch1&Ch2], [Ch3&Ch4], [Ch5&Ch6], and [Ch7&Ch8].

In SDI mode, select the Vector Channels from among [Ch1&Ch2], [Ch3&Ch4], [Ch5&Ch6], [Ch7&Ch8], [Ch9&Ch10], [Ch11&Ch12], [Ch13&Ch14], and [Ch15&Ch16].

Note: The Vector Ch is not available under Quad mode.









- **Audio Left/Right Out**

In HDMI mode, select one of the audio channel from among 1-8.

In SDI mode, select one of the audio channel from among 1-16.

Note: The Audio Left/Right Out is not available under Quad mode.

3.2.6 REMOTE

REMOTE		
	DHCP	Off
	IP Address	3 . 3 . 3 . 0
	Sub. Mask	0 . 0 . 0 . 0
	Gateway	0 . 0 . 0 . 0
	RS Type	Default
	RS ID	115
	Baud Rate	38400
	UMD Text Color	Green ▼▲
	SD12	

- **DHCP**

- [On]: The monitor will automatically get an IP address from network for remote control via various programs.

- [Off]: Manually configure IP address.

- **IP Address**

Manually configure IP address: xxx.xxx.xxx.xxx

Note: When [DHCP] on, IP address cannot be manually set .

- **Sub net Mask**

Manually configure Sub net Mask: xxx.xxx.xxx.xxx

Note: When [DHCP] on, Sub net Mask cannot be manually set .

- **Gateway**

Manually configure Gateway: xxx.xxx.xxx.xxx

Note: When [DHCP] on, Gateway cannot be manually set .

- **RS Type**

Select RS type: [Default], [TSL V3.1].

Default software connection as below,

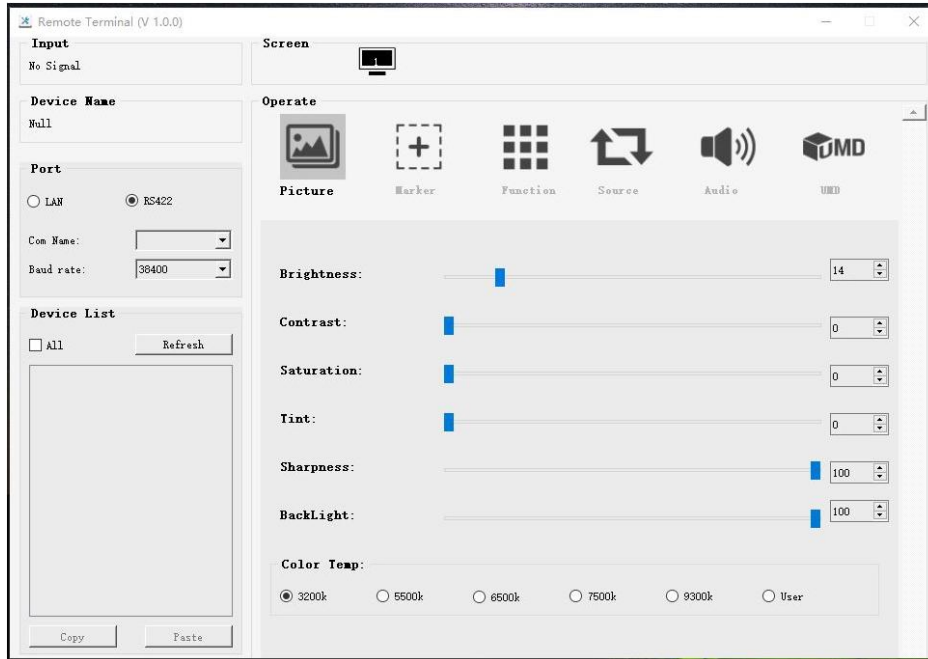

- **RS ID**

Set the ID of RS422 communication. The valid address range is between 1-126.

Note: ID must be unique in a RS422 network.

- **Baud Rate**

Select one of RS422 Baud Rate: [19200], [38400], [57600].

Note: Set the same Baud Rate in PC's monitoring software.

Note: The Baud Rate is not available under Quad mode.

- **UMD**

- UMD 1: Off, On

- UMD 1 Text Color: White, Red, Green, Blue, Yellow, Cyan, Magenta

- UMD 2: Off, On

- UMD 2 Text Color: White, Red, Green, Blue, Yellow, Cyan, Magenta

- UMD 3: Off, On

- UMD 3 Text Color: White, Red, Green, Blue, Yellow, Cyan, Magenta

- UMD 4: Off, On

- UMD 4 Text Color: White, Red, Green, Blue, Yellow, Cyan, Magenta

- **GPI 1-8**

PIN Number	GPI	Settable Values
------------	-----	-----------------

1	1	Single/ 2SI/ SQUARE HDMI
2	2	Center Marker
3	3	16:9 Marker/ 1.85:1 Marker/ 2.35:1 Marker/ 4:3 Marker/ 3:2 Marker/ 2.0X Marker/ 2.0X MAG
4	4	Marker/ Grid
5	5	SA 95%/ SA 93%/ SA 90%/ SA 88%/ SA 85%/ SA 80%
6	6	Pixel To Pixel Blue Only H/V Delay Peaking False Color Exposure Mute Level Meter Audio Vector Tally Red/ Tally Green
7	7	Power
8	Gnd	GND

[Pin Assignment]

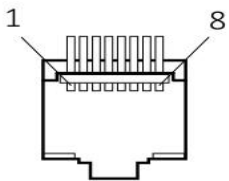

The GPI function is activated when the GPI pin is connected with the ground, and closed when it is disconnected from the ground. Connect to GPI to control the monitor remotely.

3.2.7. SYSTEM



- **Language**

Option: [Chinese], [English].

- **SFP**

Option: [On], [Off].

When the SFP on, SFP signal input can be selected via SDI-Single button on the front panel.

- **Color Bar**

Turn on/off color bar. When the color bar on, it can be selected: [100%], [75%].

Note: The Color Bar Mode is not available under Quad mode.

- **Color Bar Mode**

Option: [Rec601], [Rec709], [BT2020] color space.

Note: The Color Bar is not available under Quad mode.

- **OSD Timer**

Option: [10s], [20s], [30s].

- **OSD Transparency**

Turn on/off OSD transparency. When OSD Transparency on, option: [25%], [50%].

- **OSD H Position**

Option: 0-100. Default: 50.

- **OSD V Position**

Option: 0-100. Default: 50.

- **Info. Windows**

Option: [Off], [Standard], [Full]. Default: [Off].

- [Standard]: It supports UMD display. As show in the picture below,



- [Full]: it can support signal input, UMD and internal temperature display. As shown in the following picture,



- UMD feature in the info. windows:

Support user UMD input data on screen, ASCII: 0x20~0x7e

Support display up to 16 characters that are input by TSL protocol V3.1 on the screen.

Note: The Info. Windows is not available under Quad mode.

- **Info. Windows transparency**

Select to turn on/off info. Windows transparency, option: [Off], [25%], [50%]. Default: [Off].

Note: It is not available under Quad mode.

- **Info. Windows H/V Position**

The option range: 0-100.

Note: When [Info. Window] is selected as [Standard], its position can be adjusted freely. When [Info. Window] is selected as [Full], its vertical position can be adjusted freely.

- **Fan**

Option: [Auto], [On], [Off]. Default: [Auto].

- [Auto]: The monitor will automatically turn on/off the fan according to the setting value of fan auto temp.

Note: It is not available under Quad mode.

- **Knob**

Customized Knob function, custom option: [Brightness], [Contrast], [Saturation], [Tint], [Sharpness], [Volume], [Peaking Level], and [Back light]. Default: [Volume]. Please refer to 3.1.1 for Knob specific operation instructions.

- **Color Calibration**

Select [On] or [Off].

If the device needs to be calibrated color, please operate as following:

- Connect the device with the PC via HDMI interface.
- Make sure the device and color calibration equipment to work more than 30 minutes.
- After the previous step, activate the Color Calibration function of the device and color calibration software to calibrate the color (See the document “CMS Color Calibration Process” for details).
- It will generate a document “Rec709.cube” after calibrated, then copy this document to USB flash disk.
- Insert the USB flash disk to the device and save the document. This document “Rec709.cube” will be found under Color Space Option.

Note: It is not available under Quad mode.

- **Comparison En**

Use this setting to activate or deactivate the Comparison En function.

When activated, the screen displays the comparison of Original image and customized image, as shown,



Option: [Off], [Gamma/HDR], [Color Space], [Camera Log]. Default: [Off].

Note: It is not available under Quad mode.

- **Reset**

Select the Reset option, press the Menu knob to automatically reset.

4. Product Parameters

Panel	13.3"	15.6"	17.3"	23.6"	28"	31.5"
Resolution	3840×2160					
Brightness	300 cd/m ²	330 cd/m ²	400 cd/m ²	300cd/m ²	300cd/m ²	350cd/m ²
Contrast	1000:1	1000:1	1200:1	1000:1	1000:1	1300:1
Viewing Angle	178°/178°(H/V)	176°/176°(H/V)	170°/170°(H/V)	178°/178°(H/V)	178°/178°(H/V)	178°/178°(H/V)
Input	12G-SDI*2, 3G-SDI*2, HDMI 2.0, GPI, RS422, LAN, USB,SFP					
Output	12G-SDI*2, 3G-SDI*2, HDMI 2.0, RS422, Earphone jack					
Power In	DC 12-24V					
Power Consumption	≤31.5W	≤32.5W	≤34.5W	≤54W	≤60W	≤74W
Operating Temperature	0~50°C	0~40°C	0~50°C	0~40°C	0~40°C	0~40°C
Storage Temperature	-20~60°C	-20~60°C	-20~60°C	-20~60°C	-20~60°C	-20~60°C
Dimensions (LWD)	340×233×46 mm	393×267×51.4 mm	434×294×46 mm	567×376.4×45.7 mm	638×414.3×54.4 mm	717.5×454.7×47.4 mm
Weight	2.4KG	2.9kg	2.9kg	7.4kg	8.6kg	13.0kg

5. Accessories



● **Standard:**

- 1) 15V DC Adapter 1 pc
- 2) VESA Mount Plate Bracket 1 pc
- 3) V-mount (or Anton Bauer Mount) 1 pc
- 4) Base Bracket 1 pair
- 5) 8GB USB flash drive (User guide and software included) 1 pc



● **Optional:**

- | | |
|--|------|
| 6) SFP Optical Fiber Module | 1 pc |
| 7) Gimbal Bracket (13.3",15.6",17.3") | 1 pc |
| 8) Rack Mount Bracket(13.3",15.6",17.3",23.6",28") | 1 pc |
| 9) Carrying Case+Sunshade(15.6",17.3",23.6",28") | 1 pc |
| 10) Acrylic Screen Protector(15.6") | 1 pc |

6. Trouble Shooting

1) Only black-and-white display:

Check whether the color saturation is properly setup or not.

2) Power on but no pictures:

Check whether the cables of SDI and HDMI are correctly connected or not. Please use the standard power adapter coming with the product package. Improper power input may cause damage.

3) Wrong or abnormal colors:

Check whether the cables are correctly and properly connected or not. Broken or loose pins of the cables may cause a bad connection.

4) When on the picture shows size error:

Press "MENU → FUNCTION → Overscan" to zoom in/out pictures automatically when receiving HDMI signals.

5) Other problems:

Please press "MENU" button and choose "MENU→SYSTEM→ Reset →On".

Note: Due to constant effort to improve products and product features, specifications may change without notice.

Appendix 1: 3D LUT Loading

3D LUT supports upload color calibration document and User Log via USB flash disk.

● Format Requirement

- LUT format
 - Type: .cube
 - 3D Size: 17x17x17/33x33x33
 - Data Order: BGR
 - Table Order: BGR
- USB flash disk version
 - USB: 2.0
 - System: FAT32
 - Size: <16G
- LUT formatColor calibration document: Rec709. cube
- User Log: User1. cube-User6.cube

● LUT Format conversion

Please convert LUT format according to the following steps.

Note: For Mac users, please copy the "mac OS" file to Mac, then click and follow the steps below.

- Activate Lut converter

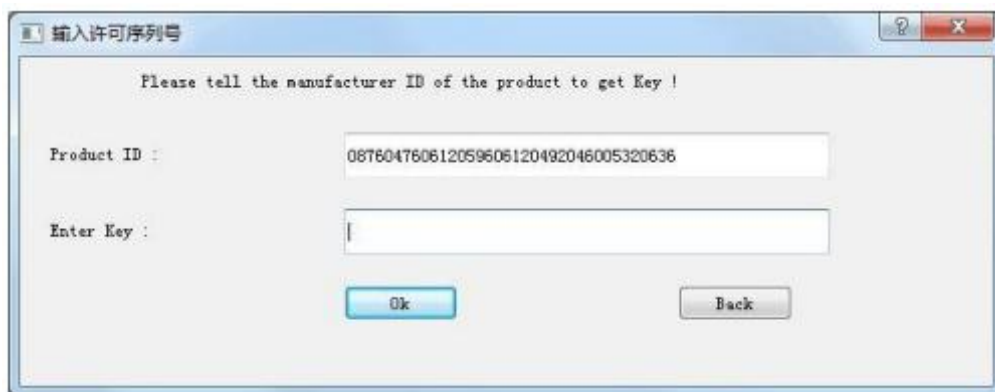

One individual Product ID for one computer. Please send the ID number to Sales to get an Enter Key.

Then the computer gets the permission of the Lut Tool after input the Enter Key.

- LightSpace CMS software user demo
 - Activate Lut Tool.exe.

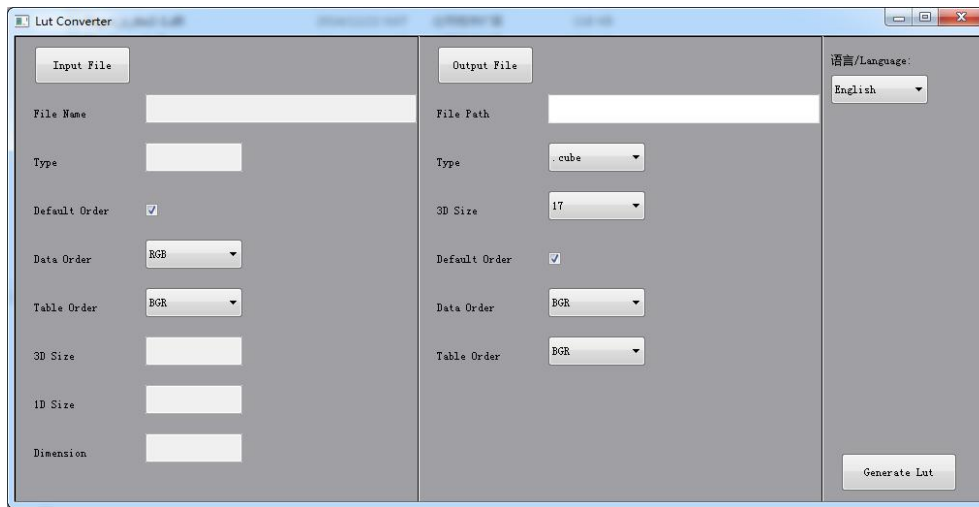

- Click Input File, then select *LUT.

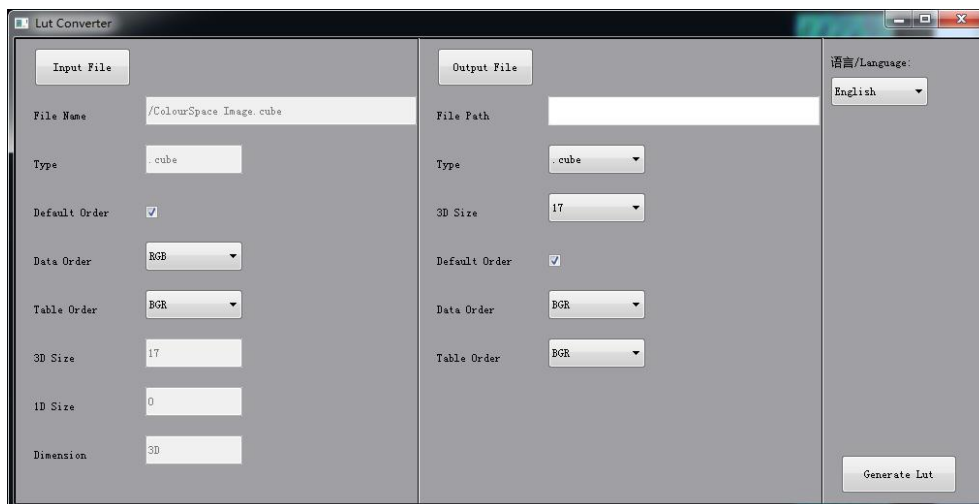

- Click Output File, choose the file name.

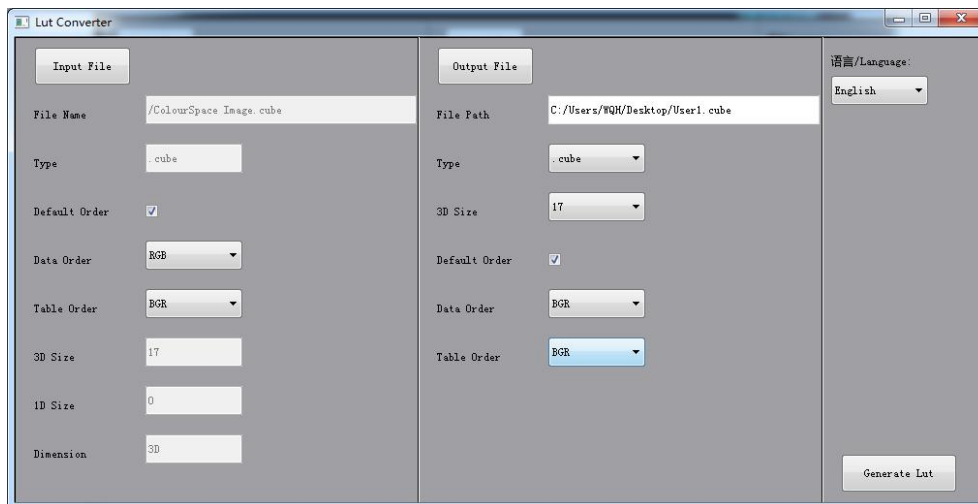

- Click Generate Lut button to finish.

● USB Loading

Copy the needed files to the root directory of the USB flash disk. Plug the USB flash disk into USB port of the device after power on. Click “Yes” on the pop-up prompt window (If the device doesn’t pop-up the prompt window, please check the LUT document name or the USB flash disk version), then press Menu button to update automatically. It will pop-up a prompt message if the update completed.

Appendix 2: Remote Terminal Instructions

Remotely control the device by Remote Terminal application.

● Home Screen

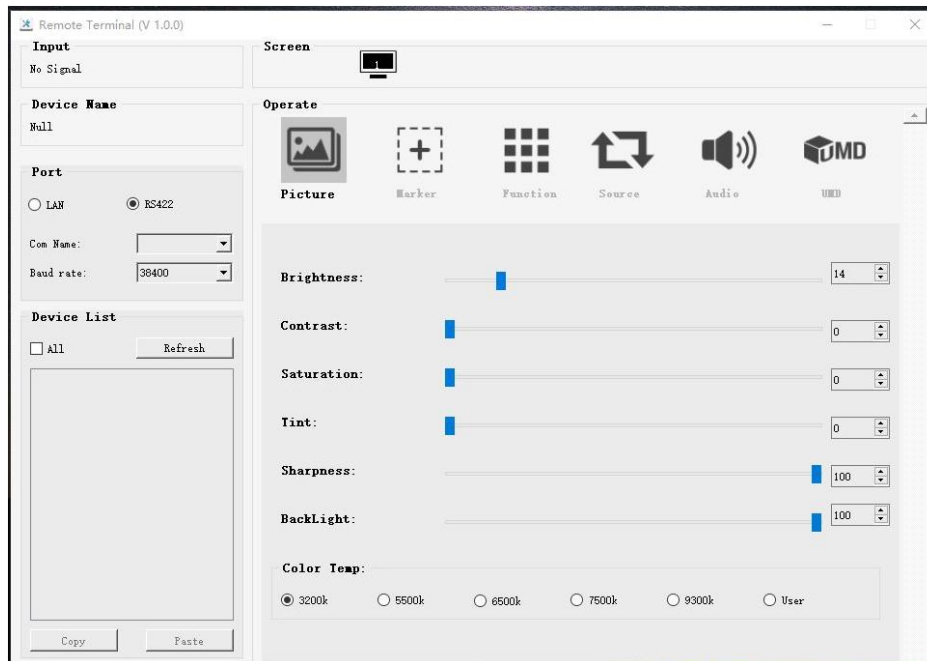

Picture: The home screen of the application

- **Input:** Display the signal format of the connected device. For example, there is “No Signal” when no device is connected or no signal is input.
 - **Device Name:** Display the Model No. of the connected device.
 - **Port:** Select the connection way of the port when connecting a device, and support “RS422” or “LAN” communication protocol.
 - **Device List:** Display all of the found peripheral device.
 - **Screen:** Display the number of screens for the selected device and the current screen index.
 - **Operate:** Operate the items for the device.
 - **Control Screen:** The control rules for the device.
- ### ● Function
- **Port Selection:** Select the specific connection port according to the device interface and click “RS422” or “LAN” to switch. When RS422 selected, it needs to further set the COM name and baud rate. For baud rate, it needs to be adapted to the baud rate of the connected device.

- Device Search: Click “Refresh” button to search devices after configuring the port. There are all of the found devices in the device list after a successful search.
- Screen Choice: The “Screen” shows the number of the screens for the current device. For the device with multiple screens, use left mouse button to click the screen icon to select the corresponding screen for operation; use right mouse button to click the screen icon to copy the screen.
- Device Control: Click the icons of [Picture], [Marker], [Function], [Source], [Audio] and [UMD] to switch the control page of the corresponding function.
- Activate “All”: Simultaneously control all of the devices in the device list if there is two or more devices with the same model after activating “All”.
- Device Copy Function: If there are two or more devices with the same model in the device list, click one of them and click “Copy” button to copy the source device, and then click the target device and click “Paste” button to copy the configuration of the source device to the target one.